

800G OSFP to RHS immersion cooling extender P/N: GLOP-PC801-DXX



Features

- ◆ Compliant OSFP MSA
- ◆ Typical insertion loss less 8dB@26.56GHz with 0.3m length
- ◆ 100ohm differential impedance system
- ◆ 3.3V power supply
- ◆ I2C R/W function
- ◆ Status indicators with LED
- ◆ 3.3V/0.85W fan and heat sink for contact cooling
- ◆ Low EMI radiation and crosstalk
- ◆ RoHS compliant

Applications

- ◆ Extend OSFP transceiver/AOC for liquid immersion link environment
- ◆ OSFP to RHS extender and adapter
- ◆ provide I2C R/W and some status indicators with LED

Description

Gigalight can offer rich experience of immersion solution, that includes different form and speed transceivers/AOC/product. Gigalight 800G OSFP to RHS immersion cooling extender (GLOP-PC801-DXX) is an important part of liquid immersion solution, this product include RHS extender cage, cable, OSFP contact three parts, the cable length can be customized no more than 0.3m, that can avoid the optical lens/engine/interface exposure to the liquid indirectly. In addition, this product can provide I2C read/write, also can show the status indicators with LED for low speed electrical hardware pins.

Liquid cooling Advantage

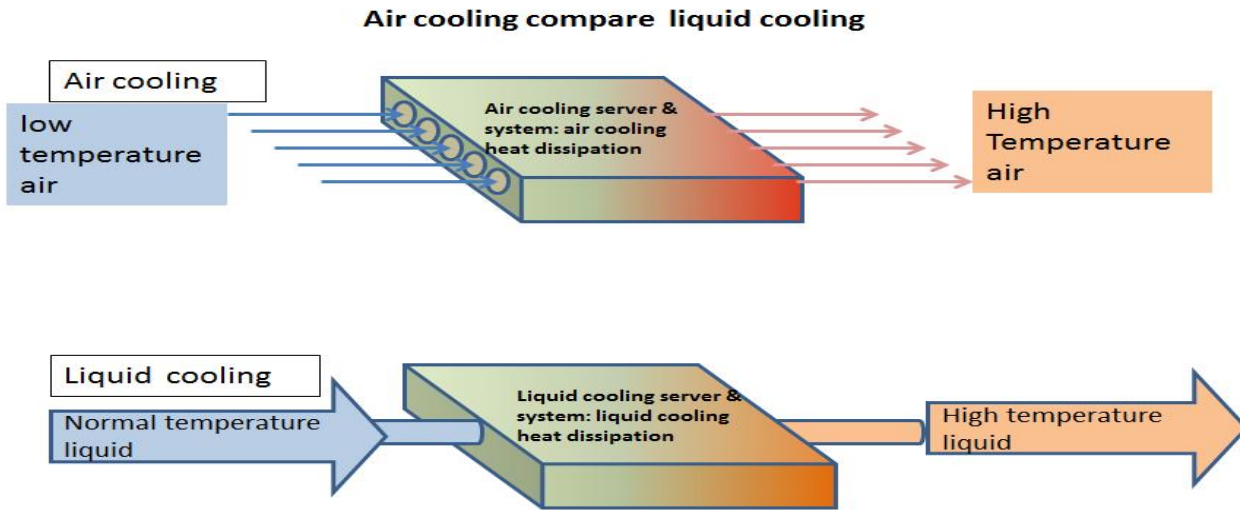

Figure 1. Liquid cooling advantage

As the requirement of data traffic keeping growth and the heat flux emitted by datacenter internal chips increases constantly, traditional air cooling methods are under pressure. Liquid cooling technologies removes the heat more efficiently with dielectric fluids that have high heat capacity to improve the efficiency of energy in datacenter.

Gigalight solved the lack of optical transceivers which perform reliability in immersion even liquid immersion depth up to 10m, the Liquid cooling optical series transceiver is suitable for liquid cooling server & system, this series product are compatible with fluorinated liquid and mineral oils well.

Immersion cooling extender can also be a important role in liquid immersion solution, existing normal OSFP form transceiver/AOC can be adapted for immersion indirectly.

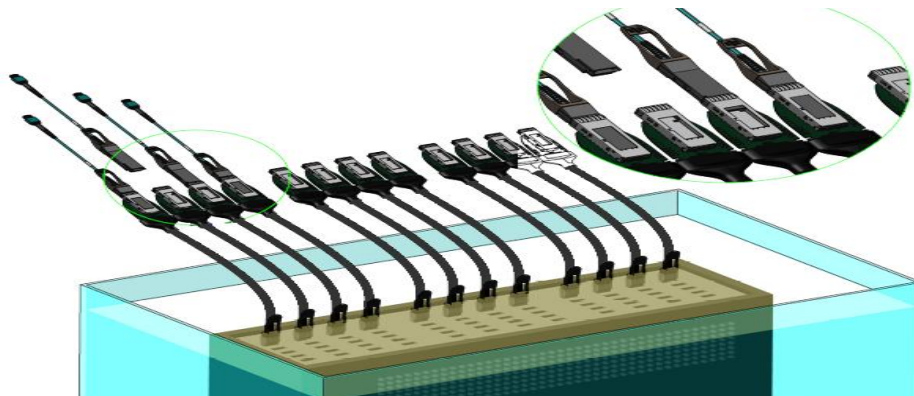

Figure 2 Immersion cooling extender under liquid

Absolute Maximum Ratings

Parameter	Symbol	Min	Max	Unit
Storage Temperature	T _s	-20	85	°C
Case Operating Temperature	T _c	0	70	°C
Humidity (non-condensing)	Rh	5	95	%

Recommended Operating Conditions

Parameter	Symbol	Min	Typical	Max	Unit
Supply Voltage	V _{cc}	3.13		3.47	V
Support Power Dissipation	P _m			16	W
Operating Case Temperature	T _c	0		70	°C
Baud Rate per Lane	fd		53.125		GBaud/s

Main Parts assembly

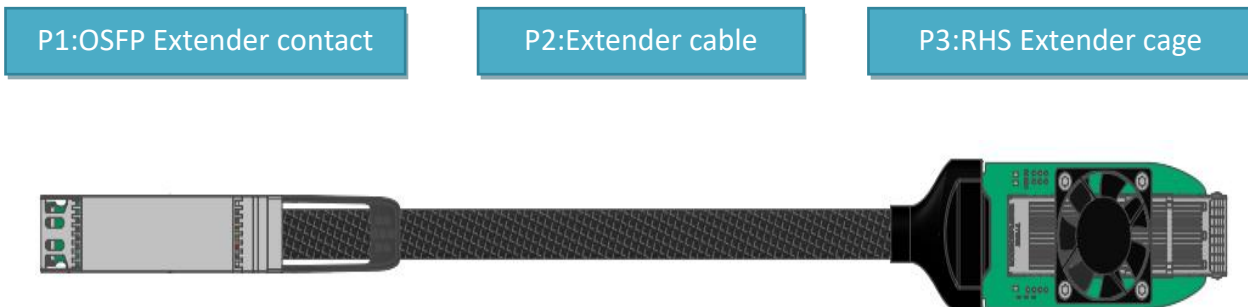

PS: The external axial flow fan of P3 side is about 1.2W. Please pay attention to safety.

Figure 3 OSFP to RHS extender main parts assembly

Electrical pinout

Top Side (viewed from top)

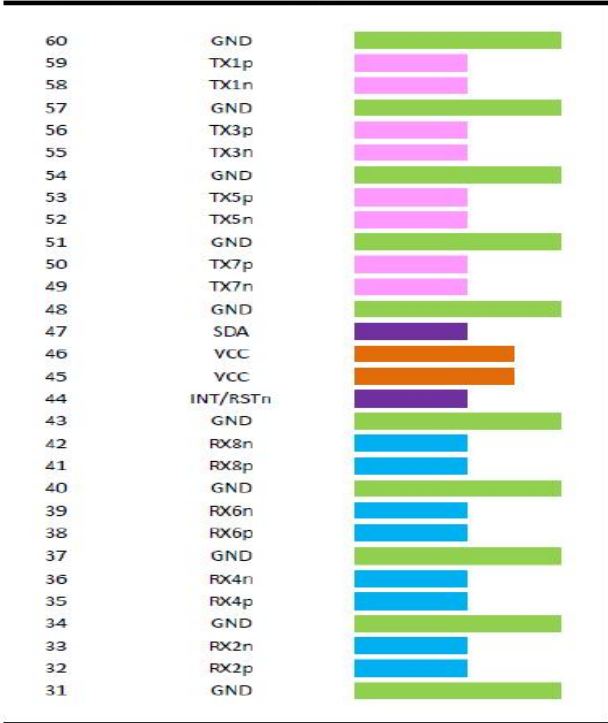

Bottom Side (viewed from bottom)

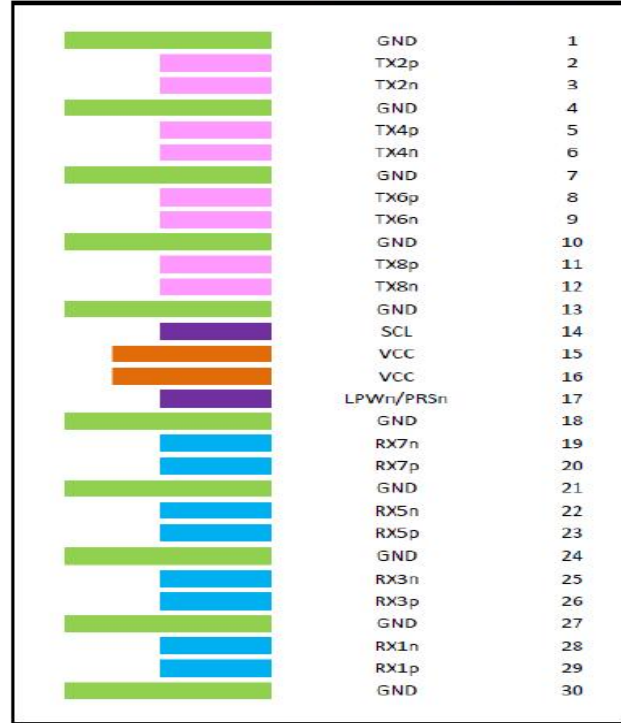

----- Module Card Edge -----

Electrical Pin-out Details

Pin#	Symbol	Description	Logic	Direction	Plug Sequence	Notes
1	GND	Ground			1	
2	TX2p	Transmitter Data Non-Inverted	CML-I	Input from Host	3	
3	TX2n	Transmitter Data Inverted	CML-I	Input from Host	3	
4	GND	Ground			1	
5	TX4p	Transmitter Data Non-Inverted	CML-I	Input from Host	3	
6	TX4n	Transmitter Data Inverted	CML-I	Input from Host	3	
7	GND	Ground			1	
8	TX6p	Transmitter Data Non-Inverted	CML-I	Input from Host	3	
9	TX6n	Transmitter Data Inverted	CML-I	Input from Host	3	
10	GND	Ground			1	
11	TX8p	Transmitter Data Non-Inverted	CML-I	Input from Host	3	
12	TX8n	Transmitter Data Inverted	CML-I	Input from Host	3	
13	GND	Ground			1	
14	SCL	2-wire Serial interface clock	LVCMOS-I/O	Bi-directional	3	Open-Drain with pull-up resistor on Host
15	VCC	+3.3V Power		Power from Host	2	
16	VCC	+3.3V Power		Power from Host	2	
17	LPWn/PRSn	Low-Power Mode / Module Present	Multi-Level	Bi-directional	3	See pin description for required circuit
18	GND	Ground			1	
19	RX7n	Receiver Data Inverted	CML-O	Output to Host	3	
20	RX7p	Receiver Data Non-Inverted	CML-O	Output to Host	3	
21	GND	Ground			1	
22	RX5n	Receiver Data Inverted	CML-O	Output to Host	3	
23	RX5p	Receiver Data Non-Inverted	CML-O	Output to Host	3	
24	GND	Ground			1	
25	RX3n	Receiver Data Inverted	CML-O	Output to Host	3	
26	RX3p	Receiver Data Non-Inverted	CML-O	Output to Host	3	
27	GND	Ground			1	
28	RX1n	Receiver Data Inverted	CML-O	Output to Host	3	
29	RX1p	Receiver Data Non-Inverted	CML-O	Output to Host	3	
30	GND	Ground			1	
31	GND	Ground			1	
32	RX2p	Receiver Data Non-Inverted	CML-O	Output to Host	3	

Pin#	Symbol	Description	Logic	Direction	Plug Sequence	Notes
33	RX2n	Receiver Data Inverted	CML-O	Output to Host	3	
34	GND	Ground			1	
35	RX4p	Receiver Data Non-Inverted	CML-O	Output to Host	3	
36	RX4n	Receiver Data Inverted	CML-O	Output to Host	3	
37	GND	Ground			1	
38	RX6p	Receiver Data Non-Inverted	CML-O	Output to Host	3	
39	RX6n	Receiver Data Inverted	CML-O	Output to Host	3	
40	GND	Ground			1	
41	RX8p	Receiver Data Non-Inverted	CML-O	Output to Host	3	
42	RX8n	Receiver Data Inverted	CML-O	Output to Host	3	
43	GND	Ground			1	
44	INT/RSTn	Module Interrupt / Module Reset	Multi-Level	Bi-directional	3	See pin description for required circuit
45	VCC	+3.3V Power		Power from Host	2	
46	VCC	+3.3V Power		Power from Host	2	
47	SDA	2-wire Serial interface data	LVC MOS-I/O	Bi-directional	3	Open-Drain with pull-up resistor on Host
48	GND	Ground			1	
49	TX7n	Transmitter Data Inverted	CML-I	Input from Host	3	
50	TX7p	Transmitter Data Non-Inverted	CML-I	Input from Host	3	
51	GND	Ground			1	
52	TX5n	Transmitter Data Inverted	CML-I	Input from Host	3	
53	TX5p	Transmitter Data Non-Inverted	CML-I	Input from Host	3	
54	GND	Ground			1	
55	TX3n	Transmitter Data Inverted	CML-I	Input from Host	3	
56	TX3p	Transmitter Data Non-Inverted	CML-I	Input from Host	3	
57	GND	Ground			1	
58	TX1n	Transmitter Data Inverted	CML-I	Input from Host	3	
59	TX1p	Transmitter Data Non-Inverted	CML-I	Input from Host	3	
60	GND	Ground			1	

Figure 4. Extender housing OSFP SMT connector pin

Mechanical Dimensions

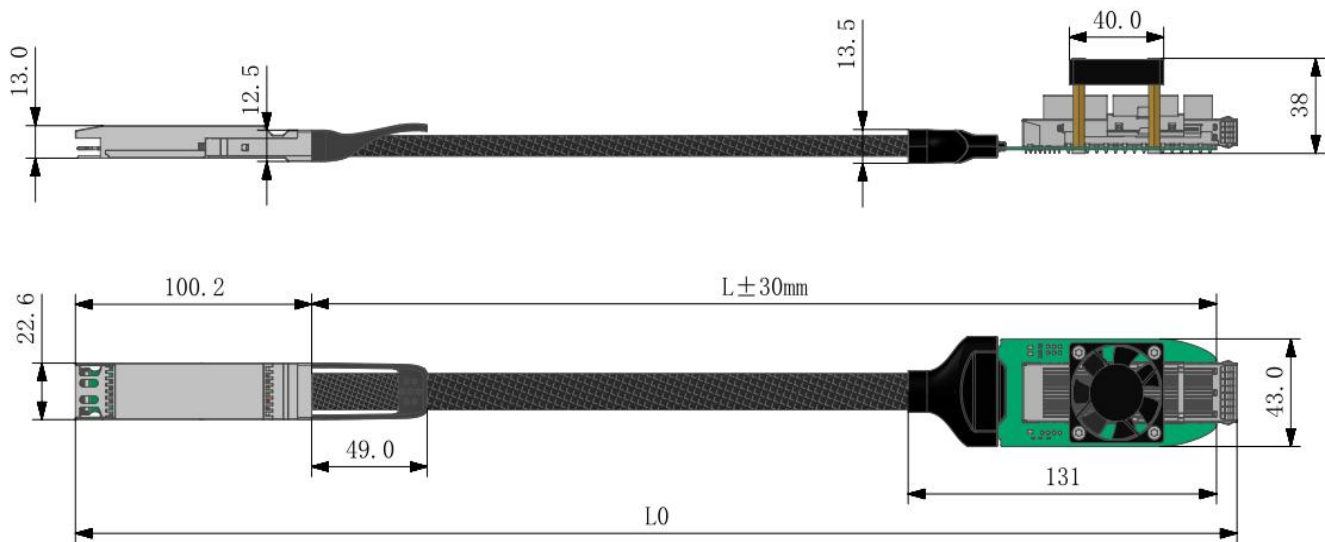

Figure 5. OSFP to RHS extender Mechanical Specifications

Extender Cage side pins

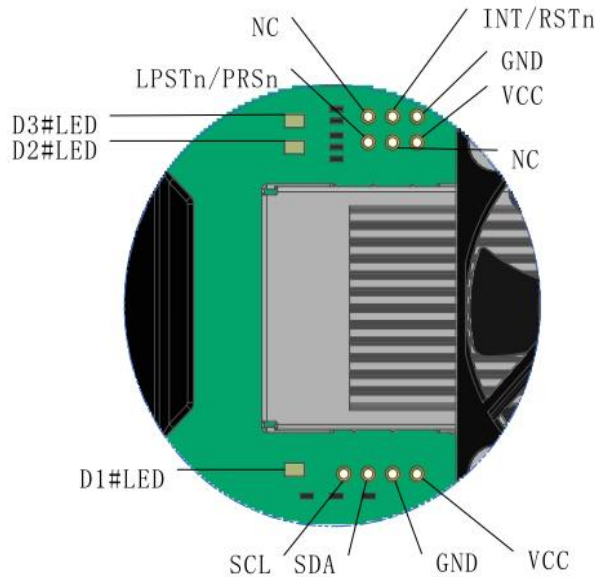

Figure 6. RHS Extender cage side pins

Regulatory Compliance

Gigalight's 800G OSFP to RHS immersion cooling extender meet the requirements of the following standards:

Feature	Standard
Electrical Safety	EN 62368-1: 2014 IEC 62368-1:2014 UL 62368-1:2014
Environmental protection	Directive 2011/65/EU with amendment(EU)2015/863
CE EMC	EN55032: 2015 EN55035: 2017 EN61000-3-2:2014 EN61000-3-3:2013
FCC	FCC Part 15, Subpart B; ANSI C63.4-2014

Ordering information

Part Number	Length	Description
GLOP-PC801-D03	30cm	800G OSFP to RHS extender with high speed cable, with PET jacket , with fan,0.3 meter length as of Figure 5.

1.The length (meter) and wire gage of GLOP-PC801-DXX is decimal and can be customizable

2.Length as "L" of Mechanical Specifications

Important Notice

Performance figures, data and any illustrative material provided in this data sheet are typical and must be specifically confirmed in writing by GIGALIGHT before they become applicable to any particular order or contract. In accordance with the GIGALIGHT policy of continuous improvement specifications may change without notice.

The publication of information in this data sheet does not imply freedom from patent or other protective rights of GIGALIGHT or others. Further details are available from any GIGALIGHT sales representative.

sales@gigalight.com.cn

<http://www.gigalight.com>

Revision History

Revision	Date	Description
V0	22-Apr-2026	Advance Release.